

Installation Instructions and Use & Care Guide



Residential Electric Water Heater

DO NOT RETURN THIS UNIT TO THE STORE



Read this manual and the labels on the water heater before you install, operate, or service it. If you have difficulty following the directions, or aren't sure you can safely and properly do any of this work yourself:

- Call our Technical Assistance Hotline at 1-888-479-8324. We can help you with installation, operations, troubleshooting, or maintenance. Before you call, write down the model and serial number from the water heater's data plate.

Incorrect installation, operation, or service can damage the water heater, your house and other property, and present risks including fire, scalding, electric shock, and explosion, causing serious injury or death.



Table of Contents..... Page

Important Safety Information	3
Getting Started	6
Installation.....	7
Troubleshooting	17
Maintenance	21
Diagrams.....	25
Repair Parts	26
Notes	27



Keep this manual in the pocket on heater for future reference whenever maintenance, adjustment or service is required.

Retain your original receipt as proof of purchase.

COMPLETED INSTALLATION (TYPICAL)

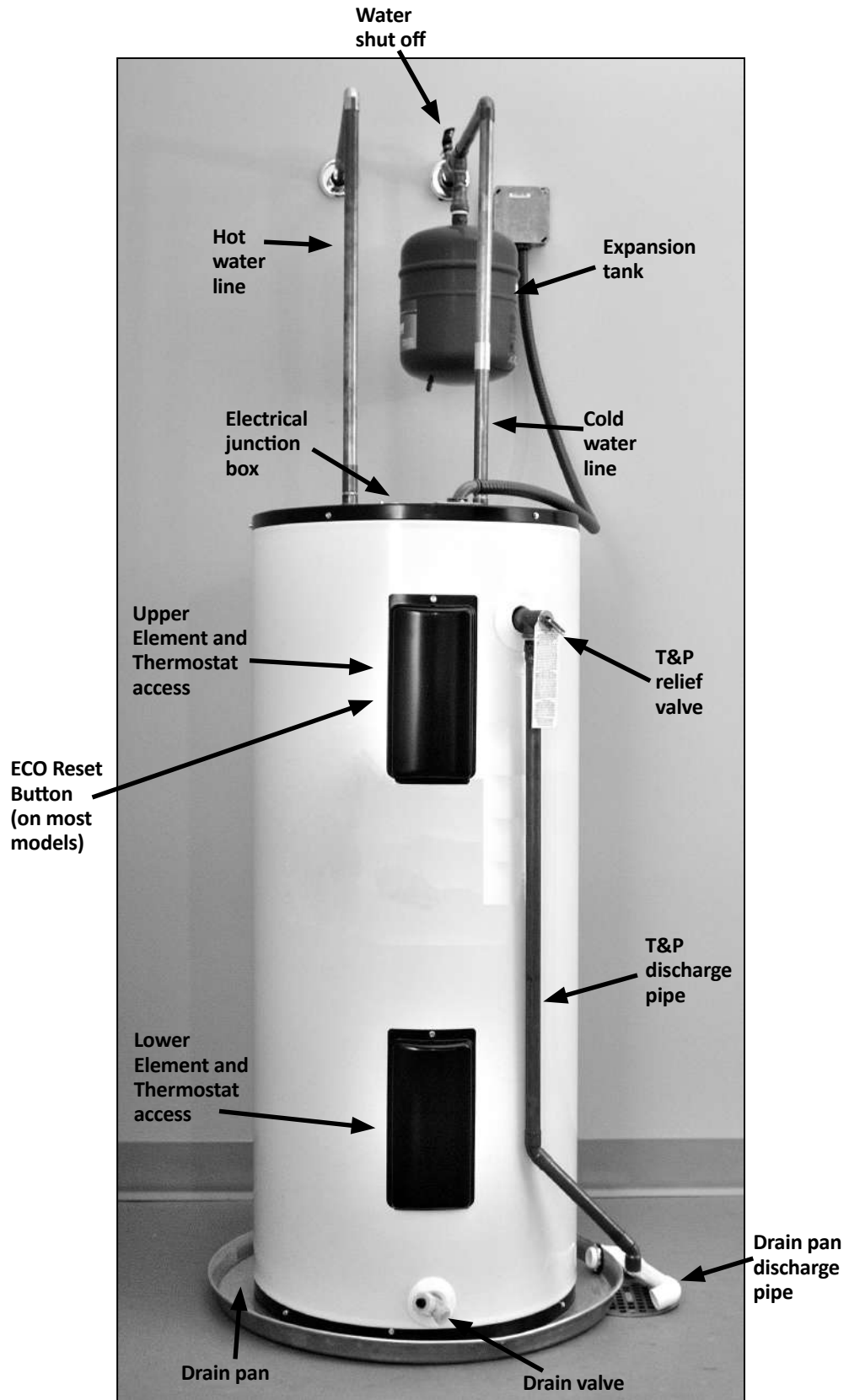

IMPORTANT SAFETY INFORMATION

To reduce the risk of property damage, serious injury or death, read and follow the precautions below, all labels on the water heater, and the safety messages and instructions throughout this manual.

RISKS DURING INSTALLATION AND MAINTENANCE



Electric Shock Risk

Contact with the electrical parts in the junction box and behind the access

doors can result in severe injury or death from electrical shock:

- Disconnect power by opening the circuit breaker or removing the fuses before installing or servicing.
- Use a non-contact circuit tester to confirm that power is off before working on or near any electrical parts.
- Replace the junction box cover and access doors after servicing.



Lifting Risk

▲ WARNING! The water heater is heavy. Follow these precau-

tions to reduce the risk of property damage, injuries from lifting or impact injuries from dropping the water heater.

- Use at least two people to lift the water heater.
- Be sure you both have a good grip before lifting.
- Use an appliance dolly or hand truck to move the water heater.

RISKS DURING OPERATION

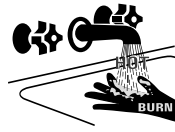

Scalding Risk

This water heater can make water hot enough to cause

severe burns instantly, resulting in severe injury or death.

- Feel water before bathing or showering
- To reduce the risk of scalding, install Thermostatic Mixing Valves (temperature limiting valves) at each point-of-use. These valves automatically mix hot and cold water to limit the temperature at the tap. Mixing valves are available from your local plumbing supplier. Follow manufacturer's instructions for installation and adjustment of the valves.
- The thermostat(s) on this water heater have been factory set to approximately 140°F (60°C) to reduce the risk of scalding. Higher temperatures increase the risk of scalding, but even at 140°F (60°C), hot water can scald. If you choose a higher temperature, Thermostatic Mixing Valves located at each point-of-use are particularly

Temperature	Time to Produce a Serious Burn
120°F (49°C)	More than 5 minutes
125°F (52°C)	1½ to 2 minutes
130°F (54°C)	About 30 seconds
135°F (57°C)	About 10 seconds
140°F (60°C)	Less than 5 seconds
145°F (63°C)	Less than 3 seconds
150°F (66°C)	About 1½ seconds
155°F (68°C)	About 1 second

important to help avoid scalding.

For information about changing the factory thermostat setting(s), refer to the "Adjusting Temperature" section in this manual (see page 15, step 10).

Even if you set the water heater thermostat(s) to a low setting, higher temperatures may occur in certain circumstances:

- In some cases, repeated small draws of water can cause the hot and cold water in the tank to "stack" in layers. If this happens, the water can be as much as thirty degrees hotter than the thermostat setting. This temperature variation is the result of your usage pattern and is not a malfunction.
- Water temperature will be hotter if someone adjusted the thermostat(s) to a higher setting.
- Problems with the thermostat(s), or other malfunctions may result in higher than expected water temperatures.
- If the water heater is in a hot environment, the water in the tank can become as hot as the surrounding air, regardless of the thermostat setting.
- If the water supplied to the water heater is pre-heated (for example, by a solar system) the temperature in the tank may be higher than the water heater's thermostat setting.

To reduce the risk of unusually hot water reaching the fixtures in the house, install Thermostatic Mixing Valves at each point-of-use.

If anyone in your home is at particular risk of scalding (for example, the elderly, children, or people with disabili-

ties) or if there is a local/provincial law requiring a certain water temperature at the hot water tap, then these precautions are particularly important.

According to a national standard American Society of Sanitary Engineering (ASSE 1070) and most local plumbing codes, the water heater's thermostat should not be used as the sole means to regulate water temperature and avoid scalds.

Properly adjusted Thermostatic Mixing Valves installed at each point-of-use allow you to set the tank temperature to a higher setting without increasing risk of scalds. A higher temperature setting allows the tank to provide much more hot water and can help provide proper water temperatures for appliances such as dishwashers and washing machines. Higher tank temperatures (140°F, 60°C) also kill bacteria that cause a condition known as "smelly water" and can reduce the levels of bacteria that cause water-borne diseases.

Water Contamination Risk

Do not use chemicals that could contaminate the potable water supply. Do not use piping that has been treated with chromates, boiler seal, or other chemicals.



Fire Risk

To reduce the risk of a fire that could destroy your home and seriously injure or kill people:

- Do not store things that can burn easily such as paper or clothes next to the water heater.
- Be sure the junction box cover and the access door covers are in place. These covers keep debris from enter-

ing and potentially being ignited, and help keep any internal fires from spreading.

- Keep the water heater from becoming wet. Immediately shut the water heater off and have it inspected by a qualified person if you find that the wiring, thermostat(s) or surrounding insulation have been exposed to water in any way (e.g., leaks from plumbing, leaks from the water heater itself can damage property and could cause a fire risk). If the water heater is subjected to flood conditions or the thermostat(s) have been submerged in water, the entire water heater must be replaced.
- Make electrical connections properly, according to the instructions on page 14. Use 10 gauge solid copper wire. Use a UL listed or CSA approved strain relief. Connect ground wire to green ground screw.



Explosion Risk

High temperatures and pressures in the water heater tank can cause an explosion resulting in property damage, serious injury or death. A new Temperature and Pressure (T&P) Relief Valve is included with your water heater to reduce risk of explosion by discharging hot water. Additional temperature and pressure protective equipment may be required by local codes.

A nationally recognized testing laboratory maintains periodic inspection of the valve production process and certifies that it meets the requirements for Relief Valves for Hot Water Supply Systems, ANSI Z21.22. The T&P Relief Valve's relief pressure must not exceed the working pressure rating of the water heater as stated on the rating plate.

Maintain the T&P Relief Valve properly. Follow the maintenance instructions provided by the manufacturer of the T&P Relief Valve (label attached to T&P Relief Valve) and the procedure that starts on page 24.

An explosion could occur if the T&P Relief Valve or discharge pipe is blocked. Do not cap or plug the T&P Relief Valve or discharge pipe.

Fire and Explosion Risk if Hot Water is Not Used for Two Weeks or More

▲ CAUTION! Hydrogen gas builds up in a hot water system when it is not used for a long period (two weeks or more). Hydrogen gas is extremely flammable. If the hot water system has not been used for two weeks or more, open a hot water faucet for several minutes at the kitchen sink before using any electrical appliances connected to the hot water system. Do not smoke or have an open flame or other ignition source near the faucet while it is open. ■

GETTING STARTED

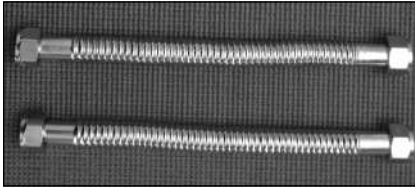

Figure 1 - Flexible connectors use compression fittings and do not require soldering.



Figure 2 - Use a non-contact circuit tester to insure that the power is off before you work on a circuit.



Figure 3 - Install a Pressure Reducing Valve set to 50 to 60 PSI.

1 Review all of the instructions before you begin work.

Improper installation can damage the water heater, your home and other property, and can present risks of serious injury or death.

2 Check with your local/provincial authorities for any local/provincial codes that apply to your area. In the absence of local/provincial codes, follow the “Canadian Electrical Code” CSA C22.1 current edition and the International Plumbing Code (IPC). The instructions in this manual comply with national codes, but the installer is responsible for complying with local/provincial codes.

3 Before you start, be sure you have, and know how to use, the following tools and supplies:

- Plumbing tools and supplies appropriate for the type of water pipes in your home
- Threaded connectors (figure 1) for the cold and hot water pipes
 - For homes plumbed with plastic pipe, use threaded connectors suitable for the specific type of plastic pipe used: CPVC and PEX (cross-linked polyethylene). Do not use PVC pipe.
 - For homes with copper pipes, you may purchase connector kits with compression fittings that don't require soldering (figure 1). Compression fittings are easier to install than soldering copper pipes.
- Teflon® tape or pipe joint compound approved for potable water
- Tools to make the electrical connec-

tions (for example, screwdrivers, wire strippers)

- Non-Contact circuit tester to check for power (figure 2)
- Water Pressure Gauge (see next page, figure 4)

Recommended Accessories:

- Suitable drain pan (see page 8, figure 6)
- Automatic leak detection and shut-off device
- Pressure Reducing Valve (figure 3)
- Thermal Expansion Tank (see next page, figure 5)
- Point-of-use Thermostatic Mixing Valves (see page 8, figure 7) ■

INSTALLATION

Follow these steps for proper installation:

Step 1:

✓ Verify that your home is equipped and up-to-date for proper operation

Installing a new water heater is the perfect time to examine your home's plumbing system and make sure the system is up to current code standards. There have likely been plumbing code changes since the old water heater was installed. We recommend installing the following accessories and any other needed changes to bring your home up to the latest code requirements.

Use the checklist below and inspect your home. Install any devices you need to comply with codes and assure that your new water heater performs at its best. Check with your local plumbing official for more information.

✓ Water pressure

We recommend checking your home's water pressure with a pressure gauge (figure 4). Most codes allow a maximum incoming water pressure of 80 psi. We recommend a working pressure no higher than 50-60 psi (345-414 kPa).

HOW: Purchase an inexpensive water pressure gauge available at local plumbing supplier. Connect the Water Pressure Gauge to an outside faucet and measure the maximum water pressure experienced throughout the day (highest water pressures often occur

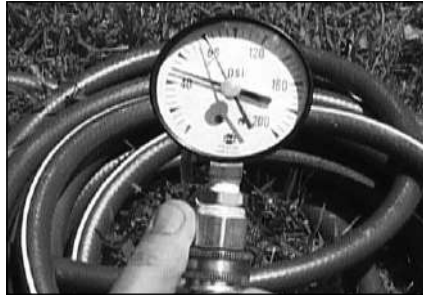

Figure 4 - Use a Water Pressure Gauge to make sure your home's water pressure is not too high.

To limit your home's water pressure: Locate your home's Pressure Reducing Valve (PRV) on the main incoming (cold) water supply line and adjust the water pressure control to between 50-60 psi (345-414 kPa). If your home does not have a Pressure Reducing Valve, install a PRV on the home's main water supply line and set it to between 50-60 psi (345-414 kPa). Pressure Reducing Valves are available at local plumbing supplier.

BACKGROUND: Over the years, many utilities have increased water supply pressures so they can serve more homes. In some homes today, pressures exceed 100 psi (689 kPa). High water pressures can damage water heaters, causing premature leaks. If you have replaced toilet valves, had a water heater leak, or had to repair appliances connected to the plumbing system, pay particular attention to your home's water pressure. When purchasing a PRV, make sure the PRV has a built-in bypass.

✓ Water pressure increase caused by thermal expansion

Verify that you have a properly sized Thermal Expansion Tank (figure 5). We recommend installing an expansion tank if your home does not have one. Codes require a properly pressurized, properly sized Thermal Expansion Tank in almost all homes. (See photo on inside front cover.)



Figure 5 - A Thermal Expansion Tank helps protect the home's plumbing system from pressure spikes.

HOW: Connect the Thermal Expansion Tank (available at local plumbing supplier) to the cold water supply line near the water heater. The expansion tank contains a bladder and an air charge. To work properly, the Thermal Expansion Tank must be sized according to the water heater's tank capacity and pressurized to match the home's incoming water pressure. Refer to the installation instructions provided with the Thermal Expansion Tank for installation details.

INSTALLATION

BACKGROUND: Water expands when heated, and the increased volume of water must have a place to go, or thermal expansion will cause large increases in water pressure (despite the use of a Pressure Reducing Valve on the home's main water supply line).

NOTICE: The main water supply line will require the use of backflow preventers and check valves to restrict water from your home reentering the public water system. Backflow preventers are often installed in water meters and may not be readily visible. As a result, most all plumbing systems today are now "closed," and almost all homes now need a Thermal Expansion Tank.

A Thermal Expansion Tank is a practical and inexpensive way to help avoid damage to the water heater, washing machine, dishwasher, ice maker and even toilet valves. If your toilet occasionally runs for no apparent reason (usually briefly at night), that may be due to thermal expansion increasing the water pressure temporarily.

Water pipe and tank leaks

Leaks from plumbing pipes or from the water heater itself can damage property and could cause a fire risk.

- Install an automatic leak detection and shutoff device (available at local plumbing supplier). These devices can detect water leaks and can shut off the water heater's water supply if a leak occurs.



Figure 6 - A suitable drain pan piped to an adequate drain can help protect flooring from leaks and drips.

- Install a suitable drain pan (available at local plumbing supplier) under the water heater (figure 6) to catch condensation or leaks in the piping connections or tank. Most codes require, and we recommend, installing the water heater in a drain pan that is piped to an adequate drain. The drain pan must be at least two inches wider than the diameter of the water heater. Install the drain pan so the water level would be limited to a maximum depth of 1-3/4" (44 mm).



Water temperature regulation



Figure 7 - Thermostatic Mixing Valves installed at each point-of-use can help prevent scalding. Install Thermostatic Mixing Valves (fig-

ure 7) to regulate the temperature of the water supplied to each point-of-use (for example, kitchen sink, bathroom sink, bath, shower). Consult the valve manufacturer's instructions or a qualified person.

▲ WARNING! Even if the water heater thermostat is set to a relatively low temperature, hot water can scald. Install Thermostatic Mixing Valves at each point-of-use to reduce the risk of scalding (see page 4).

BACKGROUND: A Thermostatic Mixing Valve, installed at each point-of-use, mixes hot water from the water heater with cold water to more precisely regulate the temperature of hot water supplied to fixtures. If you aren't sure if your plumbing system is equipped with properly installed and adjusted Thermostatic Mixing Valves at each point where hot water is used, contact a qualified person for more information. ■

Step 2:

Verify that the location is appropriate

Before installing your water heater, ensure that:

- 1 The water heater will be:
 - Installed indoors close to the center of the plumbing system.
 - In a suitable drain pan piped to an adequate floor drain or external to the building (See page 8, figure 6).
 - In an area that will not freeze
 - In an area that is suitable for installing the water heater vertically
- 2 The location has adequate space (clearances) for periodic servicing.
- 3 The floor can support the weight of a full water heater.
- 4 Your area is not prone to earthquakes. If it is, use special straps as required by local building codes.
- 5 The location is not prone to physical damage by vehicles, flooding, or other risks.

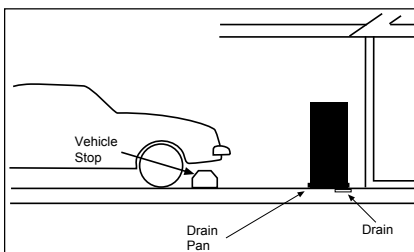

Figure 8 - In a garage, install a vehicle stop to avoid water heater damage.

- 6 Avoid locations such as attics, upper floors, or where a leak might damage the structure or furnishings. Due to the normal corrosive action of water, the tank will eventually leak. To minimize property damage from leaks, inspect and maintain your water heater in accordance with this manual's instructions. Install a suitable drain pan under the water heater piped to an adequate drain. Inspect the drain pan, pipes, and surrounding area regularly and fix any leaks found. Drain pans are available at local plumbing supplier. Leaks are frequently in the plumbing system itself and not the water heater.

Step 3:

Removing the old water heater

- 1 Read each installation step and decide if you have the necessary skills to install the water heater. Only proceed if you can safely perform the work. If you are not comfortable, have a qualified person perform the installation.
- 2 Locate the water heater's circuit breaker and turn it OFF (or remove the circuit's fuses).
- 3 On the old water heater, remove the electrical junction box access panel. Using a non-contact circuit tester, check the wiring to make certain the power is OFF.

▲ WARNING! Working on an energized circuit can result in severe injury or death from electrical shock.

- 4 Disconnect the electrical wires.
- 5 Open a hot water faucet and let the hot water run until it is cool (This may take 10 minutes or longer).



Figure 9 - Let the hot water run until it is cool.

▲ WARNING! Be sure the water runs cool before draining the tank to reduce the risk of scalding.

- 6 Connect a garden hose to the drain valve and place the other end of the hose in a drain, outside, or a bucket. (Note that sediment in the bottom of the tank may clog the valve and prevent it from draining. If you can't get the tank to drain, contact a qualified person.)
- 7 Turn the cold water supply valve OFF.
- 8 Open the drain valve on the water heater.

INSTALLATION

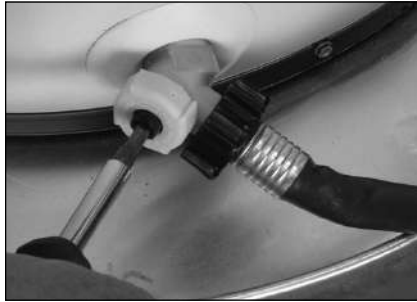

Figure 10 - Draining the old water heater.

- 9 Also open a hot water faucet to help the water in the tank drain faster.

- 10 When the tank is empty, disconnect the Temperature & Pressure (T&P) Relief Valve discharge pipe. You may be able to reuse the discharge pipe, but do not reuse the old T&P Relief Valve. A new T&P Relief Valve comes installed on your water heater (or on some models, is in the carton with the water heater).



Figure 11 - Removing the T&P Relief Valve discharge pipe.

- 11 Disconnect the water pipes. Many water pipes are connected by a threaded union which can be disconnected with wrenches. If you must cut the water pipes, cut the pipes close to the water heater's inlet and outlet connections, leaving the water pipes as long as possible. If necessary, you can make

them shorter later when you install the new water heater.

- 12 Remove the old water heater.

▲ WARNING! Use two or more people to remove or install water heater. Failure to do so can result in back or other injury.

Step 4:

Installing the new water heater

- 1 Completely read all instructions before beginning. If you are not sure if you can complete the installation, **DO NOT RETURN THIS UNIT TO THE STORE.** Seek assistance from any of the following sources:

- Schedule an appointment with a qualified person to install your water heater.
- Call our Technical Assistance Hotline at .

- 2 Install a suitable drain pan that is piped to an adequate drain.

- 3 Set the water heater in place taking care not to damage the drain pan.

NOTICE: Most codes require setting the water heater in a suitable drain pan piped to an adequate drain. The drain pan helps avoid property damage which may occur from condensation or leaks in the piping connections or tank. The drain pan must be at least two inches (51 mm) wider than the diameter of the water heater. Install the drain pan so the water level is limited to a maximum depth of 1-3/4" (44 mm).

- 4 Verify that the water heater is properly set in place. Check that:

- The T&P Relief Valve will not be in contact with any electrical parts.
- There is adequate space to install the T&P Relief Valve discharge pipe and that it can be piped to a separate drain (and not into the drain pan).
- There is adequate access and space around the water heater for future maintenance.

DO NOT CONNECT ELECTRICAL WIRING UNTIL YOU ARE INSTRUCTED TO DO SO.

NOTICE: Connecting electrical power to the tank before it is completely full of water (water must run FULL STREAM from a hot water tap for a full three minutes) will cause the upper heating element to burn out.

Step 5:

Connect the Temperature and Pressure (T&P) Relief Valve/Pipe

Most T&P Relief Valves are pre-installed at the factory. In some cases, they are shipped in the carton and must be installed in the opening marked and provided for this purpose and according to local/provincial codes.

▲ WARNING! To avoid serious injury or death from explosion, install a T&P Relief Valve according to the following instructions:

1 If your water heater does not have a factory installed T&P Relief Valve, install the new T&P Relief Valve that came with your water heater. Do not reuse an old T&P Relief Valve. Install a T&P Relief Valve discharge pipe according to local codes and the following guidelines:

- The discharge pipe should be at least 3/4" (19 mm) inside diameter and sloped for proper drainage. Install it to allow complete drainage of both the T&P Relief Valve and the discharge pipe.

- The discharge pipe must withstand 250°F (121°C) without distortion. Use only copper or CPVC pipe. Do not use any other type of pipe, such as PVC, iron, flexible plastic pipe, or any type of hose.



Figure 12 - The T&P Relief Valve discharge pipe must be installed properly and piped to an adequate drain.

- Terminate the discharge pipe a maximum of 12 inches (304.8 mm) above a floor drain or outside the building. Do not drain the discharge pipe into the drain pan; instead pipe it separately to an adequate drain. In cold climates, terminate the discharge pipe inside the building to an adequate drain. Outside drains could freeze and obstruct the drain line. Protect the drain from freezing.

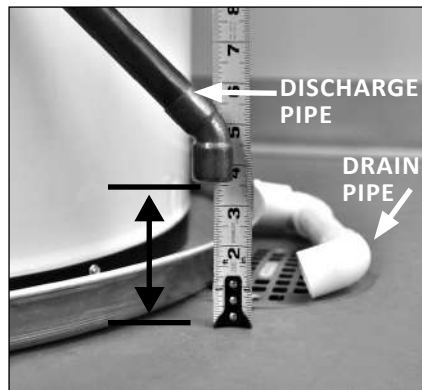

Figure 13 - The end of the T&P Relief Valve discharge pipe must stop no more than six inches above a floor drain or terminate outside the building.

INSTALLATION

Step 6:

Install shutoff and tempering valves

1 If one is not already installed, install a manual shutoff valve in the cold water line that supplies the water heater. Install the shutoff valve near the water heater so that it is readily accessible. Only use valves that are compatible with potable water. Use only full-flow ball or gate valves. Other types of valves may cause excessive restriction to the water flow.

2 Install a Thermostatic Mixing Valve at each point-of-use (for example, kitchen sink, bathroom sink, bath, shower). Consult the valve manufacturer's instructions or a qualified person.



Figure 14 - Install Thermostatic Mixing Valves at each point where hot water will be used.

▲ WARNING! Even if the water heater's thermostat(s) are set to a relatively low temperature, hot water can scald. Install Thermostatic Mixing Valves at each point-of-use to reduce the risk of scalding. (See page 4.)

3 For water heaters that are fed by a solar water heating

system (or any other pre-heating system), always install a Thermostatic Mixing Valve or other temperature limiting device in the inlet water supply line to limit water supply inlet temperature to 120°F (49°C). Solar water heating systems can supply water with temperatures exceeding 170°F (77°C) and may result in water heater malfunction.

▲ WARNING! Hot water provided by solar heating systems can cause severe burns instantly, resulting in severe injury or death (see page 4).

Step 7:

1 Connect the water supply

Determine the type of water pipes in your home. Most homes use copper water pipes, but some use CPVC or cross-linked polyethylene (PEX). Use fittings appropriate for the type of pipe in your home. Do not use iron or PVC pipe – they are not suitable for potable water.

2 Connect the cold water supply using 3/4 inch (19mm) National Pipe Thread "NPT" to the cold water inlet nipple.

For ease of removing the water heater for service or replacement, connect the water pipes with a coupling called a union. We recommend using a dielectric-type union (available at local plumbing supplier). Dielectric unions can help prevent corrosion caused by tiny electric currents common in copper water pipes and can help extend the life of the water heater.

IF YOU HAVE COPPER PIPES:

If your home has copper water pipes, you can solder the water pipe connections or use compression fittings which don't require soldering. Compression fittings are easier to install than soldering pipe. Check with local plumbing officials to determine what types of pipe materials are suitable for your location. Do not use lead-based solder.

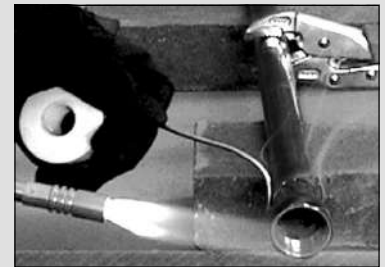

NOTICE: Do not solder pipes while they are attached to the water heater. The water heater's inlet and outlet connections contain non-metallic parts which could be damaged. The proper way to connect the water heater to copper water pipes is as follows:

- Solder a short length of pipe (about a foot or so) to a threaded adapter using only 95/5 tin-antimony or equivalent solder. Attach the threaded adapters to the water heater's connections (using Teflon® tape or pipe joint compound). Connect the home's water pipes by soldering, keeping the connections at the water heater cool with wet rags.

NOTICE: Most water heater models contain energy saving heat traps in the inlet and outlet connections to avoid the circulation of hot water within the pipes. Do not remove the heat traps.

3 Connect the hot water supply using 3/4 inch (19mm) NPT to the hot water outlet. Follow the same connection guidelines as for the cold water supply.

4 Install insulation (or heat tape) on the water pipes especially if the indoor installation area is subject to freezing temperatures. Insulating the hot water pipes can increase energy efficiency.

5 Double check to make sure the hot and cold water pipes are connected to the correct hot and cold water fittings on the water heater.

6 If needed, install (or adjust) the home's Pressure Reducing Valve to 50-60 psi (345-414 kPa) and install a Thermal Expansion Tank.



Figure 15 - A Pressure Reducing Valve is required if your home's water pressure is above 80 psi (552 kPa).



Figure 16 - The Thermal Expansion Tank should be pressurized with air, to match the home's incoming water pressure.

Step 8:

Verify connections and completely fill tank

To remove air from the tank and allow the tank to fill completely with water, follow these steps:

1 Remove the aerator at the nearest hot water faucet. This allows any debris in the tank or plumbing system to be washed out.

2 Turn the cold water supply back on.

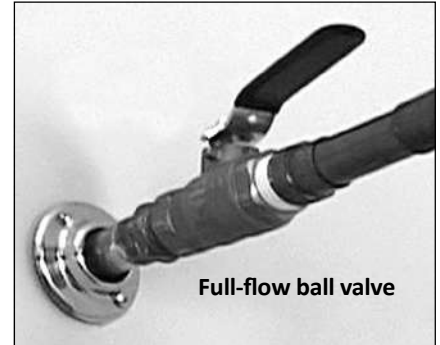

Figure 17 - Fully open the cold water supply valve.

3 Open a hot water faucet and allow the water to run until it flows with a full stream.

4 Let the water run full stream for three full minutes.

5 Close the hot water faucet and replace the aerator.

6 Check inlet and outlet connections and water pipes for leaks. Dry all pipes so that any drips or leaks will be apparent. Repair any leaks. Almost all leaks occur at connections and are not a tank leak.

INSTALLATION



NOTICE: The tank must be completely empty of air and full of water before connecting electrical power to avoid “Dry Firing.” Dry Firing may result in the upper element burning out. This is a common installation mistake. After you make the water connections, but before you connect the electrical power, open a hot water faucet and let the water run full until all the air is removed. Let the “hot” water run full for three minutes or longer before connecting any electrical wires. A Dry Fired upper heating element is an installation error and is not covered under warranty.

If Dry Firing occurs, replace the upper heating element according to the instructions on page 22.

Step 9:

Make electrical connections

▲ WARNING! Working on an energized circuit can result in severe injury or death from electrical shock.

NOTICE: Do not turn electrical power on unless you are sure all of the air is out of the tank and the tank is completely full of water. If power is applied before the tank is completely full of water, the upper element will burn out (Dry Fire).

- 1 Be sure the electrical power to the water heater is turned OFF at the circuit breaker panel (or remove the circuit’s fuses).
- 2 Using a non-contact circuit tester, check the wiring to make certain the power is OFF.
- 3 Check the water heater’s data plate and ensure that the home’s voltage, wiring size (ampacity) and circuit breaker rating and type are correct for this water heater. Refer to the wiring diagram located on the water heater for the correct electrical connections. Ensure that wire sizes, type, and connections comply with all applicable local codes. In the absence of local/provincial codes, follow the “Canadian Electrical Codes” CSA C22.1 current.
- 4 Remove the cover on the electrical junction box on the top of the water heater.



Figure 18 - The water heater’s electrical requirements can be determined from the data plate.

- 5 Install wiring in an approved conduit (if required by local codes). Use a UL listed or CSA approved strain relief to secure the electrical wiring to the water heater.
- 6 Connect the ground wire to the green ground screw. Connect the home’s two power wires to the water heater’s two power wires. Use suitable wire nuts or other approved means to make the power connections.



Figure 19 - Connecting the electrical wires.

- 7 Replace the junction box cover and secure with the screws provided.

▲ WARNING! Be sure cover is secured to reduce the risk of fire and electric shock.

Step 10:

Adjusting the Temperature

With the installation steps completed, you may adjust the water heater's temperature setting if desired.

- 1 Set the thermostat(s) to desired temperature. The thermostat(s) on this water heater have been factory set to approximately 120°F (49°C) to reduce the risk of scald injury. You may wish to set a higher temperature to provide hot water for automatic dishwashers or laundry machines, to provide more hot water capacity, and to reduce bacterial growth. Higher tank temperatures (140° F, 60°C) kill bacteria that cause a condition known as "smelly water" and can reduce the levels of bacteria that cause water-borne diseases.

▲ WARNING! Higher temperatures increase the risk of scalding, but even at 120°F (49°C), hot water can scald (see page 4).

If you increase the water heater's temperature setting, install Thermostatic Mixing Valve(s) at each point-of-use to reduce the risk of scalding.



Figure 20 - Adjust Thermostatic Mixing Valves at each point-of-use to 120°F (49°C) or lower.

To adjust the water heater's thermostat:

- Be sure the electrical power to the water heater is turned OFF at the circuit breaker panel (or remove the circuit's fuses).

▲ WARNING! Working near an energized circuit can result in severe injury or death from electrical shock. Check wires with a circuit tester to make sure power is off.

- Remove the upper and lower access panels and fold away the insulation.
- Turn the water temperature dial clockwise (>>) to increase the temperature, or counter clockwise (<<) to decrease the temperature. Adjust both thermostats to the same temperature setting. To avoid a shortage of usable hot water, do not adjust the upper thermostat to a temperature setting that is higher than the lower thermostat's temperature setting.

NOTE: Most models have two thermostats, but some models may only have one. If your water heater has only one thermostat, it is located behind the

lower access panel.

- Fold the insulation back in place and replace the access panels.

▲ WARNING! Be sure panels are secured to reduce the risk of fire and electric shock.

- 2 Turn the electric power back on.

- 3 Wait for the water to heat up. It may take several hours for a tank of cold water to heat up.

If you have no hot water after two hours, refer to the Troubleshooting Section (see page 17).

▲ WARNING! If you have increased the temperature setting and the Thermostatic Mixing Valves are not set properly (or not installed) you could scald yourself while checking the temperature.

- 4 Check water temperature at several points of use in your home (for example, bathtub faucet, shower, or lavatory sink) and adjust the Thermostatic Mixing Valves as needed. If you aren't sure how to adjust the Thermostatic Mixing Valve settings, or aren't sure if you have Thermostatic Mixing Valves, contact a qualified person.

TROUBLESHOOTING

PROBLEM	POSSIBLE CAUSE(S) See explanations on the following pages.	CORRECTIVE ACTION
NO HOT WATER (page 18)	<ul style="list-style-type: none"> • No power to water heater • Burned out upper heating element (Dry Fired) • Energy Cut Off Switch tripped • Faulty Thermostatic Mixing Valve • Non-Functioning upper thermostat • Leak in plumbing system 	<p>Check for blown fuses or tripped circuit breaker. Check for power.</p> <p>Replace upper heating element.</p> <p>See page 19, step 5.</p> <p>Check hot water at other faucets.</p> <p>Check/replace upper thermostat. (See page 23)</p> <p>Check hot water side of home's plumbing system for leaks.</p>
INSUFFICIENT HOT WATER (page 19)	<ul style="list-style-type: none"> • Thermostats set too low • Non-Functioning lower heating element • Water heater's capacity too small (or usage too high) • Thermostatic Mixing Valve faulty/set too low • Non-Functioning lower thermostat • Hot and cold pipe connections reversed • Leak in plumbing system • Melted dip tube 	<p>Set thermostats to desired temperature. See page 15.</p> <p>Replace lower heating element. (See page 22)</p> <p>Install adequately sized water heater (or reduce usage).</p> <p>Check hot water at other faucets.</p> <p>Replace lower thermostat. (See page 23)</p> <p>Correct piping.</p> <p>Check hot water side of home's plumbing system for leaks.</p> <p>Check/replace dip tube.</p>
SLOW HOT WATER RECOVERY (page 19)	<ul style="list-style-type: none"> • Low supply voltage • Malfunctioning lower heating element 	<p>Check power (voltage).</p> <p>Check lower element and replace if burned out. (See page 22)</p>
TEMPERATURE TOO HIGH (page 20)	<ul style="list-style-type: none"> • Non-functioning thermostat • Grounded/shorted heating element • Thermostatic Mixing Valve faulty/set too high 	<p>Replace thermostat. (See page 23)</p> <p>Replace heating element. (See page 22)</p> <p>Check hot water at other faucets.</p>
LOW WATER PRESSURE (page 20)	<ul style="list-style-type: none"> • Partially closed supply valve. 	See Low Water Pressure section on page 20.
DRIPS FROM T&P RELIEF VALVE (page 20)	<ul style="list-style-type: none"> • Excessive water pressure • Thermal expansion • Debris under valve seat 	<p>Use Pressure Reducing Valve set to 50-60 psi (345-414 kPa).</p> <p>Install a Thermal Expansion Tank.</p> <p>See page 20.</p>
WATER ODOR (page 20)	<ul style="list-style-type: none"> • Bacteria in the water 	See Water Odor section on page 20.

TROUBLESHOOTING

▲ WARNING! Working near an energized circuit can result in severe injury or death from electrical shock.

▲ WARNING! When you are finished, be sure all covers are secured to reduce the risk of fire and electric shock.

No Hot Water

The most likely reasons for an electric water heater to produce NO hot water are:

- No electric power—a common problem with new installations
- Burned out upper element (Dry Fired) — a common problem with new installations
- Tripped Energy Cut Off (red button on upper thermostat)
- The water heater's inlet and outlet connections are reversed (usually only in new installations)
- Broken upper thermostat (or wiring)
- A leak in the hot water side of the plumbing system that exceeds the water heater's heating capacity and makes it appear that the water heater is producing little to no hot water

Follow these steps to diagnose and correct common electrical problems:

1 Check the electric power to the water heater. No hot water is often caused by a problem with the home's electrical wiring or circuit breakers. You'll need a non-contact circuit tester. Follow these guidelines:

- Locate the water heater's circuit breaker and turn it off (or remove the circuit's fuses).

- Locate the electrical junction box on top of the water heater and remove the cover.
- Identify the two power wires. The power wires are usually black/black or black/red—the green or copper wire is the ground wire.



Figure 21 - Use a non-contact circuit tester to check for electrical power.

- Turn the circuit breaker back on (or install the fuses) and check the power on both incoming power wires using a non-contact circuit tester.
- Turn the power off and replace the cover on the electrical junction box.

If the water heater is not getting power, contact a qualified person to have your home's wiring or circuit breakers checked.

2 Check the upper heating element. If the water heater is getting electrical power, check to see if the upper heating element has burned out. If the upper element is burned out, you'll have no hot water. To check the upper element, you'll need a multimeter capable of reading resistance.

- Turn the power OFF at the circuit breaker or remove fuses.
- Remove the upper access panel.
- Remove the insulation to access the upper thermostat and heating element.

3 Check the top two screws of the upper thermostat using a non-contact circuit tester and confirm that power is off (screw terminals 1 and 3 in photo on next page).

- With the electrical power off, remove the two power wires from the upper heating element.

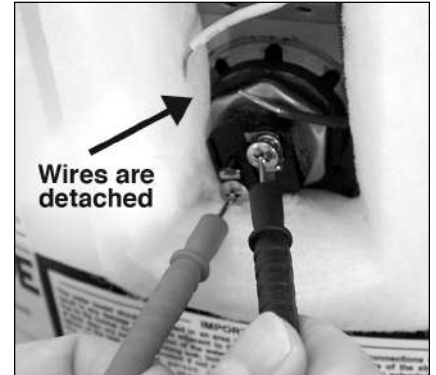

Figure 22 - Use a multimeter to check the resistance of the upper heating element.

4 Check the resistance of the upper heating element using a multimeter. Measure the resistance between the two screw terminals on the upper heating element. A good element will have a resistance ranging between 5 and 25 Ohms. If the resistance is:

Outside this range. Replace the element (see the Routine Maintenance section on page 22). On a new water heater, a burned out upper heating element is almost always caused by turning the power on before the tank was completely full of water (Dry Fire). (See Step 8 in the Installation section.)

Within this range. Reattach the power wires, making sure the wires are in good condition and the connections are clean and tight. Next, check the following:

5

Check/Reset Energy Cut Off (ECO) Button.

Figure 23 - Energy Cut Off (ECO) button

The Energy Cut Off (ECO) shuts off power to the water heater's elements if the temperature of the water in the tank gets too hot. If the ECO has tripped, you'll have no hot water. A tripped ECO can usually be reset, but you should have a qualified person investigate the cause of the overheating and repair the problem. Do not turn the power back on until the cause of the overheating has been identified and repaired.

To check the Energy Cut Off (ECO)

- Turn off the power to the water heater.

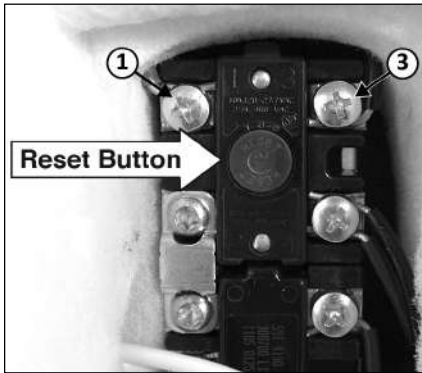
▲ WARNING! Working near an energized circuit can result in severe injury or death from electrical shock. Check power wires in the electrical junction box with a non-contact circuit tester to make sure power is off.

- Press the red ECO reset button (see photo above).
- The ECO was tripped if you hear a click when it is reset. In most cases, a tripped ECO indicates that the tank overheated due to a problem with one of the elements or thermostats—have a qualified person check the upper and lower elements and thermostats and replace if necessary.
- The ECO was not tripped if you didn't hear a click. In that case, the upper

thermostat should be checked by a qualified person.

- Replace the insulation and the upper access panel.

WARNING! Be sure all covers are secured to reduce the risk of fire and electric shock.

Insufficient Hot Water or Slow Hot Water Recovery

▲ WARNING! Because of the increased risk from scalding, if you set the water heater's thermostat(s) higher than 120°F (49°C), Thermostatic Mixing Valves at each point-of-use are particularly important (see page 4).

If the hot water is simply not warm enough, there are several possible causes:

- Faulty Thermostatic Mixing Valve in a faucet or shower control (check other faucets in the house for hot water)
- One (or both) of the thermostats set too low
- Water heater's capacity too small (or usage too high)
- Reversed plumbing connections or melted dip tube (usually found soon after new installation)
- Plumbing leak
- Bad lower heating element (or lower thermostat)
- Low supply voltage

Thermostatic Mixing Valves. If the hot water is simply not warm enough, make sure the faucet you are checking doesn't have a defective Thermostatic Mixing Valve. Many shower controls now have built-in mixing valves. If these devices fail, they can reduce the amount of hot water the shower or faucet delivers even though there is plenty of hot water in the tank. Always check the water temperature at several

faucets to make sure the problem is not in a faucet or shower control.

Thermostats set too low. If the water temperature at several faucets is too cool, adjust the thermostat(s) according to the instructions in Step 10 of the Installation section of this manual.

Undersized water heater. If your water heater runs out of hot water too quickly, it may be too small for your needs. If the water heater is old, consider replacing it with a larger model. If the water heater is in good condition, you may be able to meet your family's hot water needs with the existing water heater by installing Thermostatic Mixing Valves at each point-of-use and then turning the thermostat(s) to a higher setting. See page 15, step 10.

You can also reduce your home's hot water needs by washing clothes in cold water, installing flow restrictors on shower heads, repairing leaky faucets, and taking other conservation steps.

Reversed connections or melted dip tube. Check the hot and cold connections and make sure your home's hot water pipe is connected to the hot water outlet on the water heater. Usually, reversed connections are found soon after the installation of a new unit. If copper pipes were soldered while they were attached to the water heater, the dip tube may have melted. The dip tube is a long plastic tube inside the tank attached to the cold water inlet. If the dip tube has melted, it can be replaced by removing the cold water inlet connection, removing the old dip tube and installing a new one.

Plumbing leak. Even a small leak in the hot water side of the home's plumbing system can make it appear that the water heater is producing little to no hot water. Locate and repair the leak.

Lower heating element not working. If the lower heating element (or, more rarely, the lower thermostat) is not

TROUBLESHOOTING

working, you will have some hot water but not as much as before. Because the lower element does most of the work, the lower element usually wears out before the upper element. Replace the lower element and/or thermostat if necessary (see page 22-23).

Temperature Too High

If the water temperature is too hot:

- Install or adjust the Thermostatic Mixing Valves for each point-of-use (see manufacturer's instructions), or
- Adjust the thermostat(s) on the water heater (see Step 10 in the installation section of this manual).

A nonfunctioning thermostat or a shorted heating element can cause extremely hot water. If the Temperature and Pressure Relief Valve (T&P Valve) releases large amounts of very hot water, it is likely due to a shorted heating element, or more rarely a nonfunctioning thermostat, or the thermostat does not fit snugly against the tank. Very high water temperatures can also cause the Energy Cut Off (ECO) to trip (see page 19). Turn power off until this problem is fixed.

Low Water Pressure

Check both the cold and hot water at a sink to determine if the lower pressure is only on the hot water side. If both hot and cold faucets have low pressure, call your local water utility. If the low pressure is only on the hot water side, the primary causes of this are:

- Melted heat traps or dip tube. Soldering copper pipes while they are connected to the water heater can melt the heat traps inside the hot and cold water connections or the dip tube (cold water side). Melted heat traps or

a melted dip tube can restrict the flow of hot water. If that's the case, replace the heat traps or dip tube.

- Partially closed supply valve. Open the water heater's supply valve fully.

Drips from T&P Relief Valve Discharge Pipe

A small amount of water dripping from the Temperature and Pressure (T&P) Relief Valve usually means the home's water pressure is too high or you need a properly sized and pressurized Thermal Expansion Tank. Refer to Step 1 in the Installation section of this manual for more information. A large amount of hot water coming from the T&P discharge pipe may be due to the tank overheating.

▲ WARNING! Do not cap or plug the T&P relief valve or discharge pipe, and do not operate the water heater without a functioning T&P Relief Valve - this could cause an explosion.

Water pressure too high. High water pressure can cause the T&P Relief Valve to drip. Install a Pressure Reducing Valve (PRV) on the main cold water supply line. Adjust the PRV to between 50-60 psi (345-414 kPa).

Thermal Expansion Tank. Install a Thermal Expansion Tank. If a Thermal Expansion Tank is already installed and the T&P Relief Valve discharge pipe drips, the Thermal Expansion Tank may be pressurized to the wrong pressure or the internal bladder may be defective. Refer to the instructions that came with the Thermal Expansion Tank for more information.

Debris. In rare cases, debris can stick inside the T&P Relief Valve preventing the valve from seating fully. In that case, the T&P Relief Valve discharge

pipe will drip. You may be able to clear debris from the T&P Relief Valve by manually operating the valve, allowing small quantities of water to flush out the debris. See the label on the T&P Relief Valve for instructions.

If the water pressure is between 50-60 psi (345-414 kPa), a Thermal Expansion Tank is installed and properly pressurized, and the valve has been cleared of any debris, and it still drips, the valve may be broken—have a qualified person replace the T&P relief valve.

Water Odor

Harmless bacteria normally present in tap water can multiply in water heaters and give off a "rotten egg" smell. Although eliminating the bacteria that causes "smelly water" with a Chlorination system is the only sure treatment, in some cases, the standard anode rod that came with your water heater can be replaced with a special zinc anode rod which may help reduce or eliminate the odor. Contact a qualified person.

NOTE: To protect the tank, an anode rod must be installed in the water heater at all times or the warranty is void.

In cases where the "rotten egg" smell is pronounced, you can raise the tank temperature to 140°F (60°C) in order to reduce bacteria growth in the tank.

▲ WARNING! Because higher temperatures increase the risk of scalding, if you set the thermostat(s) higher than 120°F (49°C), Thermostatic Mixing Valves at each point-of-use are particularly important (see page 4). ■

MAINTENANCE

Routine Maintenance

Routine maintenance will help your water heater last longer and work better. If you can't perform these routine maintenance tasks yourself, contact a qualified person.

Water Heater Maintenance

After the first six months, drain and flush the water heater and inspect the anode rod. Depending on the hardness of your water, repeat this process at least annually, or more frequently if needed. From time to time you may need to replace a heating element or a thermostat. All three maintenance tasks are described below.

Draining and Flushing the Water Heater

Tap water contains minerals that can form lime deposits on heating elements or sediment in the bottom of the tank. The amount of lime deposits or sediment depends on the hardness of your tap water. The rate at which sediment builds up depends on water quality and hardness in your area, the temperature settings, and other variables. We recommend draining and flushing the water heater after the first six months of operation to determine the amount of sediment build up. Draining sediment extends the life of the tank, heating elements, and drain valves.

- In areas with very hard water, remove and check the heating elements whenever you drain the tank. If you have heavy lime deposits on heating elements, you will need to replace them more often.
- Sediment may form large masses that can prevent the tank from draining. Have a qualified person use a de-liming agent suitable for potable water to remove the sediment buildup.
- In most cases, it is easier and cheaper to replace lime-encrusted elements

than trying to remove heavy lime deposits.

To drain and flush the tank:

- 1 Locate the water heater's circuit breaker and turn it OFF (or remove the circuit's fuses).



Figure 24 - Circuit Breaker

- 2 Open a hot water faucet and let the hot water run until it is cool.



Figure 25 - Water Faucet

▲ WARNING! Be sure the water runs cool before draining the tank to reduce the risk of scalding.

- 3 Connect a garden hose to the drain valve and place the other end of the hose in a drain, outside, or in buckets.
- 4 Turn the cold water supply valve OFF.
- 5 Open the drain valve on the water heater.



Figure 26 - Drain Valve

- 6 Open a hot water faucet to help the water in the tank drain faster.

NOTICE: DO NOT turn electrical power back on unless the tank is completely full of water.

- 7 Remove and inspect the anode rod (see Repair Parts Illustration on back cover for location of the anode rod). Replace the anode rod if it is depleted. Turn power off. Run hot water until it's cool. Turn cold water supply valve off. Open a hot water faucet to depressurize tank. Locate and remove the black plastic cover marked "Anode" Use a "key hole" saw or similar tool to remove the foam insulation covering the anode rod. Once the anode rod is exposed, use a 1 1/16" socket wrench with an extension to remove it. Inspect the anode rod and replace if depleted. Apply Teflon® tape or pipe joint compound and reinstall the anode rod tightly. It is not necessary to replace the foam removed to access the anode. Turn cold water supply valve on. When hot water runs full, close hot water faucet. Check for leaks and repair if necessary. Turn power on.

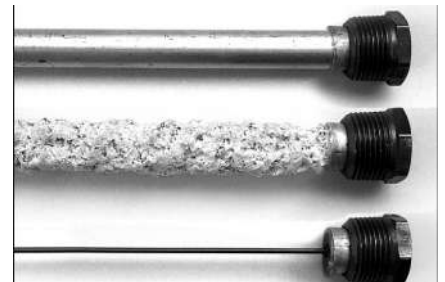

Figure 27 - Anode Rods from new (top) to partially depleted (middle) to fully depleted stage (bottom)

Anode Rod. The anode rod is a sacrificial metal rod that helps reduce corrosion and premature failure (leaks) in the tank. The anode rod is a consumable item. Inspect the anode rod after the first six months of operation when you drain and flush the tank. Replace the anode rod if it is substantially worn out or depleted. Thereafter, inspect the anode rod annually or more frequently if needed. If you use a water softener, your anode rod will deplete faster than normal. Inspect the anode rod more frequently, replacing

MAINTENANCE

the anode rod as needed. Obtain new anode rods from local plumbing supplier or have a qualified person replace it. (Anode rods are a consumable item and are not covered under warranty).

- 8 If the sediment was present when the tank was drained, flush the tank by opening the cold water supply valve and letting the water run until no more sediment drains from the tank. Close the drain valve when you are done.

NOTICE: Do not turn power back on until the tank is completely full of water. For complete instructions on filling the tank, follow Step 8 in the Installation section.

- 9 Refill the tank by opening the cold water supply valve. Make sure a hot water faucet is open and the drain valve is closed. Allow the hot water to run full for at least three minutes to make sure the tank has all the air removed and is completely full of water. Failure to perform this step can cause the upper heating element to burn out. Once you are certain the tank is completely full of water, close the hot water faucet.

- 10 Restore power to the water heater. It may take two hours for the tank to heat up.

Replacing the Heating Element

▲ WARNING! Working on an energized circuit can result in severe injury or death from electrical shock. Turn power off. Check wires with a non-contact circuit tester to make sure power is off. When you are finished, be sure all covers are secured to reduce the risk of fire and electric shock.

If you are not comfortable replacing a heating element or thermostat yourself, have this work done by a qualified person. To replace the heating element, you'll need the following tools and supplies:



Figure 28 - Non-Contact Circuit Tester

- Always turn power OFF and check the power wires with a non-contact circuit tester before working on the water heater.



Figure 29 - Heating Element (with gasket)

- Check your water heater's data plate for the correct wattage and voltage. Heating elements are available at most hardware stores.



Figure 30 - Element Wrench

- Some regular sockets (1 1/2 inch SAE) may work, but regular sockets are often beveled and may slip. Inexpensive element wrenches are available at local plumbing supplier.
- Garden hose to drain the tank
- Hand dishwashing soap to lubricate the gasket
- A clean cloth to clean the threaded opening
- A flat blade and a Phillips screwdriver

Steps for Replacing the Heating Element:

- 1 Turn the power OFF at the circuit breaker or remove fuses.



Figure 31 - Circuit Breaker

- 2 Open the electrical junction box on top of the water heater. Using a non-contact circuit tester, check the power wires to make certain the power is OFF.



Figure 32 - Non-Contact Circuit Tester

- 3 Open a hot water faucet and let the hot water run until it is cool.



Figure 33 - Water Faucet

▲ WARNING! Be sure the water runs cool before draining the tank to reduce the risk of scalding.

- 4 Connect a garden hose to the drain valve and place the other end of the hose in a drain or outside (or use buckets). Turn OFF the cold water valve that supplies the water heater. Opening a hot water faucet will help the tank drain faster.

- Remove the upper or lower access panel on the water heater, and then fold back the insulation and remove the plastic element/thermostat cover.



Figure 34 - Access Panel

- With the tank drained and power off, remove the power wires from the element you intend to replace.
- Remove the bad element using an element wrench.
- Make sure the new element is the correct replacement by referring to the water heater's data plate for voltage and wattage information.
- Clean the threads in the tank opening with a rag. Insert the new element equipped with a rubber gasket. **NOTE:** Use a drop of hand dishwashing liquid to lubricate the gasket to help avoid damaging the gasket as it is being tightened. Tighten with an element wrench.

NOTICE: Do not turn power back on until the tank is completely full of water. For complete instructions on filling the tank, follow Step 8 in the Installation section.

- Refill the tank by opening the cold water supply valve. Make sure a hot water faucet is open and the drain valve is closed. Allow the hot water to run full for at least three minutes to make sure the tank has all

the air removed and is completely full of water. Failure to perform this step can cause the upper heating element to burn out. Once you are certain the tank is completely full of water, close the hot water faucet.



Figure 35 - Drain Valve

- Check the newly installed element for leaks. If a leak is present, tighten the element until the leak stops. If you cannot stop the leak, drain the tank and remove the element. Inspect the gasket for damage. If the gasket is damaged, replace the gasket and re-install the element.
- Once the element is successfully installed and there are no leaks, replace the power wires, thermostat cover, insulation, and access panel. Make sure all wire connections are tight. Replace the cover on the electrical junction box.
- Restore power to the water heater. It may take two hours for the tank to heat up.

Replacing the Thermostat

▲ WARNING! Working on an energized circuit can result in severe injury or death from electrical shock. Turn power off. Check wires with a non-contact circuit tester to make sure power is off. When you are finished, be sure all covers are secured to reduce the risk of fire and electric shock.

To replace the thermostat, you'll need the following tools and supplies:

- A non-contact circuit tester. Always

turn power OFF and check with a non-contact circuit tester before working on the water heater.

Figure 36 - Upper and Lower Thermostats

- A replacement thermostat (available at local plumbing supplier). Note that the upper and lower thermostats are different (above). Some models only have one thermostat.
- A business card to check the gap between the thermostat and the tank
- Tape and a permanent marker to mark the wires
- A flat blade and a Phillips screwdriver

Steps for Replacing the Thermostat:

- Turn the power OFF at the circuit breaker or remove fuses.

NOTICE: It is not necessary to drain the tank to replace a thermostat.
- Open the electrical junction box on top of the water heater. Using a non-contact circuit tester, check the power wires to make certain the power is OFF.



Figure 37 - Non-Contact Circuit Tester

- Remove the upper or lower access panel on the water heater and carefully fold back the insulation and plastic element/thermostat cover.
- Make sure the replacement thermostat matches the

MAINTENANCE

original thermostat.

- 5 Mark the wires with tape so you'll know how to put them back on.
- 6 Disconnect the wires from the bad thermostat and remove the thermostat from the metal mounting clip.
- 7 Install the new thermostat in the metal mounting clip.
- 8 Make sure the new thermostat fits snugly against the tank. You should NOT be able to slip a business card between the thermostat and the tank. If you can, bend the thermostat mounting clip until the thermostat fits tightly against the tank.
- 9 Attach the wires following the wiring diagram on the water heater's label. Make sure all wire connections are tight.
- 10 Replace the plastic element/ thermostat cover, insulation, and access panel.
- 11 Replace the cover on the electrical junction box.
- 12 Restore power to the water heater. It may take two hours for the tank to heat up.

T&P Relief Valve Maintenance

Read and follow the operating and annual maintenance instructions provided by the manufacturer of the T&P Relief Valve (yellow label attached to T&P Relief Valve). Minerals in the water can form deposits that cause the valve to stick or create blocked passages, making the T&P Relief Valve inoperative. Follow these guidelines:

- At least annually, operate the T&P Relief Valve manually to ensure the waterways are clear and the valve mechanism moves freely (above). Before operating the valve manually, check that it will discharge in a place for secure disposal. If water does not flow freely from the end of the discharge pipe, turn OFF the power to the water heater. Call a qualified person to determine the cause.

▲ WARNING! Hot water will be released. Before operating the T&P relief valve manually, check that it will discharge in a safe place. If water does not flow freely from the end of the discharge pipe, turn the power to the water heater OFF. Call a qualified person to determine the cause.



Figure 38 - T&P Relief Valve

- At least every five years, have a qualified person inspect the T&P Relief Valve and discharge pipe. Damage caused by corrosive water conditions,

mineral deposits, or other problems can only be determined when a qualified person removes and inspects the valve and its components.

- Note that a dripping T&P Relief Valve is usually caused by the home's water pressure being too high or the lack of a Thermal Expansion Tank. If your T&P Relief Valve drips, see page 20.

DIAGRAMS

Thermostat Wiring Diagram

A-6
TWO WIRE CIRCUIT FOR NON-SIMULTANEOUS
OPERATION, HAS SINGLE HIGH LIMIT CONTROL

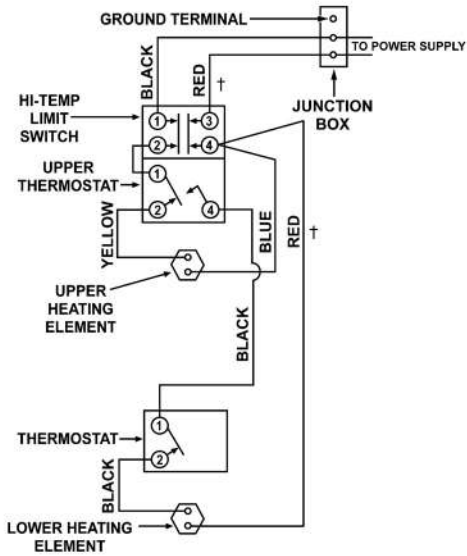

C-2
STANDARD SINGLE ELEMENT

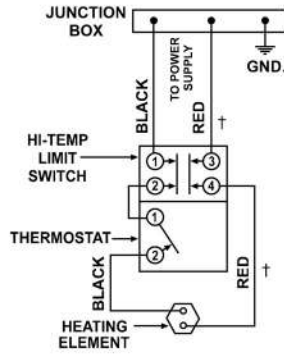

† 120V AND 277 WILL HAVE WHITE WIRE
IN PLACE OF RED.

MAXIMUM ALLOWABLE SIMULTANEOUS OPERATION
5000/5000 WATTS AT 208 VOLTS 5500/5500 WATTS AT 240
VOLTS. ANY WATTAGE USAGE HIGHER THAN LISTED ABOVE
EXCEEDS ALLOWABLE AMP DRAW AND WILL CAUSE DAMAGE
TO THE WATER HEATER.

REPAIR PARTS

Key No.	Part Description
1	TEMPERATURE-PRESSURE RELIEF VALVE
2	SECONDARY ANODE ROD/NIPPLE w/HEAT TRAP*
3	ELEMENT w/GASKET
4	ELEMENT GASKET
5	LOWER OUTER DOOR
6	TERMINAL COVER (DOUBLE ELEMENT)
7	UPPER THERMOSTAT w/HI LIMIT (DOUBLE ELEMENT)
8	TERMINAL COVER
9	LOWER THERMOSTAT w/HI LIMIT (SINGLE ELEMENT)
10	TERMINAL COVER
11	LOWER THERMOSTAT (DOUBLE ELEMENT)
12	THERMOSTAT BRACKET (EA.)
13	DRAIN VALVE
14	PRIMARY ANODE
15	HEAT TRAP/DIP TUBE COMBO
16	NIPPLE w/HEAT TRAPS*
17	UPPER OUTER DOOR
18	BASE PAN w/SIDE DRAIN
19	PIPE INSULATION

* If Applicable

** Not Illustrated

Repair parts may be ordered through your plumber, local distributor, local plumbing supplier, or by calling . When ordering repair parts always give the following information:

1. Model and serial number.
2. Item number and part description.

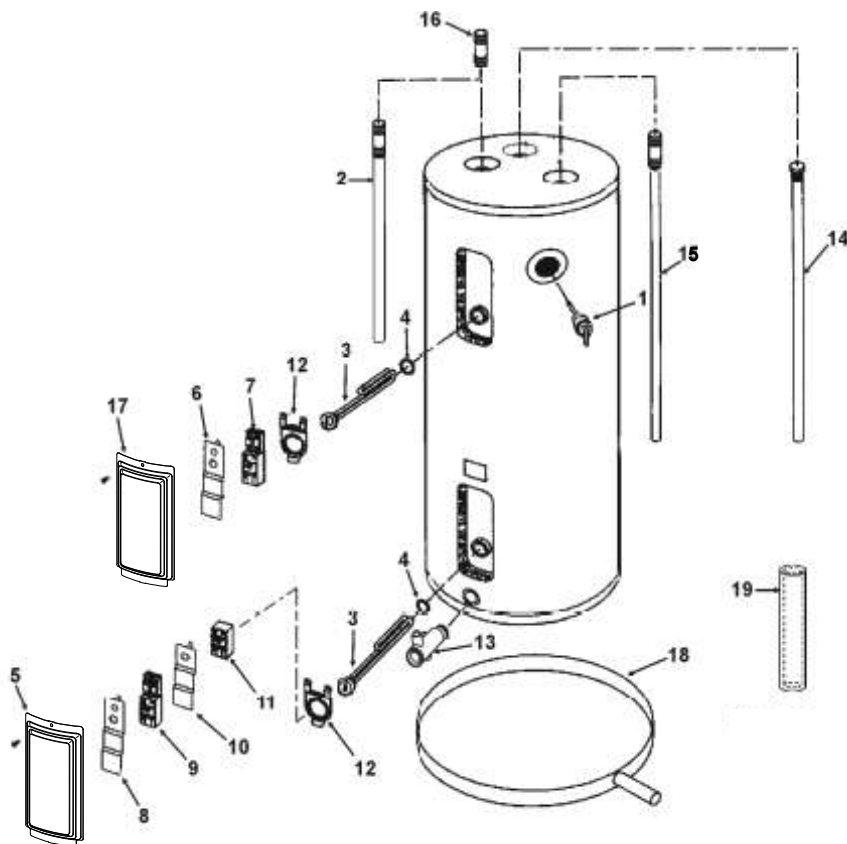

®Teflon is a registered trademark of E.I. Du Pont De Nemours and Company

John Wood Water Heaters

599 Hill Street West

Fergus, ON Canada N1M 2X1

Should you have any questions, please

Visit us online at www.johnwoodwaterheaters.com, or

E-mail us at techsupport@gsw-wh.com, or

Call our Technical Support line at 1 888 GSW TECH (479 8324)

All Rights Reserved.